

Data Sheet



Article number: 07105303001

Description: Universal joint double 0.105.303.001
S=150 X= Bore 20 H7 with keyway

Measures

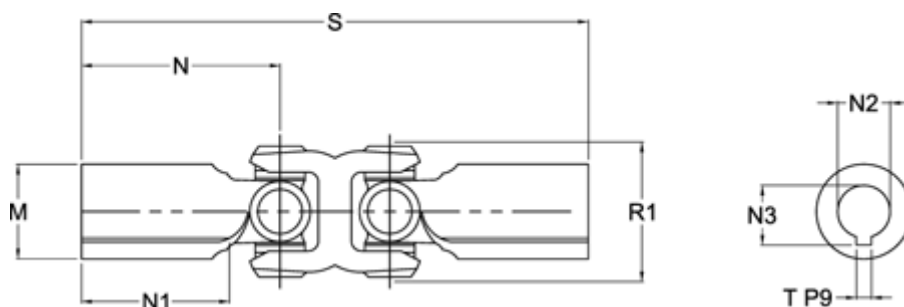

M	= 36	T = 6 P9
Max. Bending Angle degrees	= 30	
N	= 50	
N1	= 25	
N2	= 20 H7	
N3	= 22,8 +0,2	
R1	= 52	
S min	= 150	